









STORAGE BED ASSEMBLY INSTRUCTION

WARNING

Please use REDlocking mechanism when bed is raised, to prevent any danger of matters platform falling down when ottoman in use. Failure to do so may result in injury.



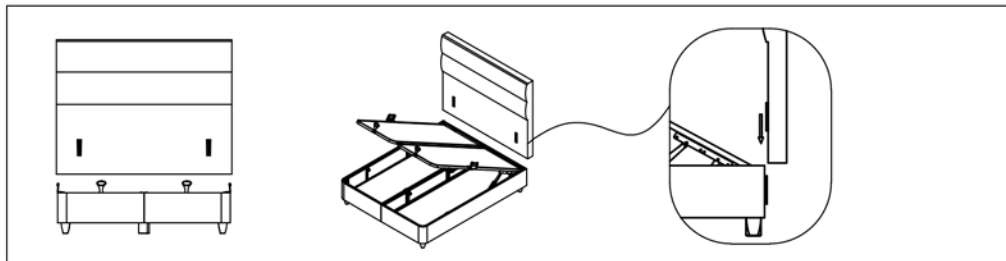
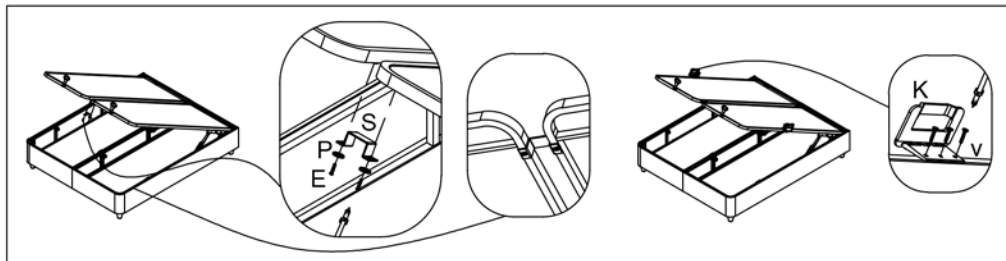
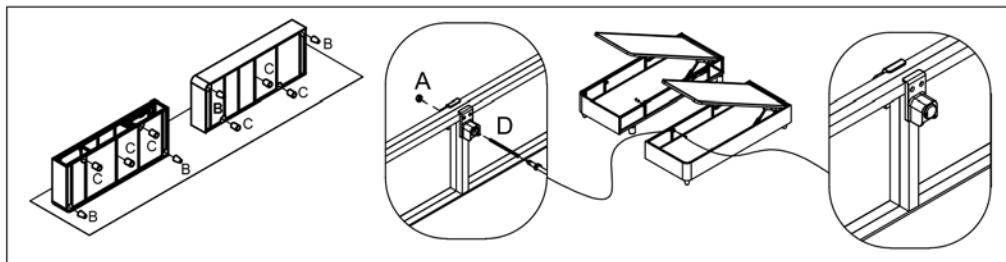
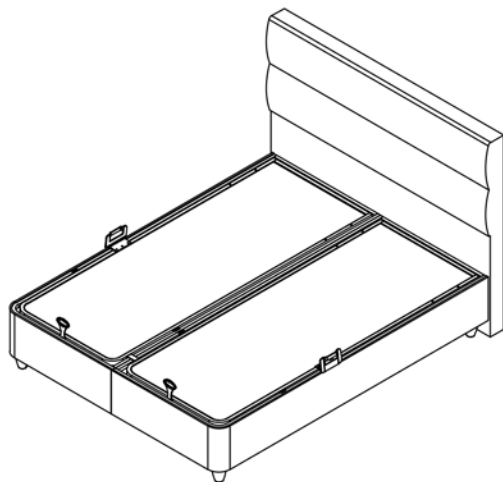





A M8 1x 	B 4x 	C 6x 
D YSB M8x100 1x 	E YSB M8x25 2x 	S 1x 
K 2x 	V YHB 3,9x22 6x 	P PUL KALIN 3/8 INC 2x 



STORAGE BED ASSEMBLY INSTRUCTION

WARNING

Please use REDlocking mechanism when bed is raised, to prevent any danger of matters platform falling down when ottoman in use. Failure to do so may result in injury.

A M8 1x 	B 4x 	C 6x 
D YSB M8x100 1x 	E YSB M8x25 2x 	S 1x 
K 2x 	V YHB 3,9x22 6x 	P PUL KALIN 3/8 INC 2x 